



**EVOTECH**<sup>®</sup>  
P E R F O R M A N C E

Ducati Scrambler 1100  
Tail Tidy

Installation Instructions



## Kit Contents PRN014118

- (A) 1 x Reflector Kit
- (B) 1 x P-Clip
- (C) 1 x M4 x 8mm Black Button Head Bolts
- (D) 2 x M4 x 10mm Capheads
- (E) 2 x M5 x 12mm C/Sink
- (F) 2 x Spacer (Rear Light Spacer)
- (G) 2 x Spacer
- (H) 4 x M6 x 16mm Black Button Head Bolts

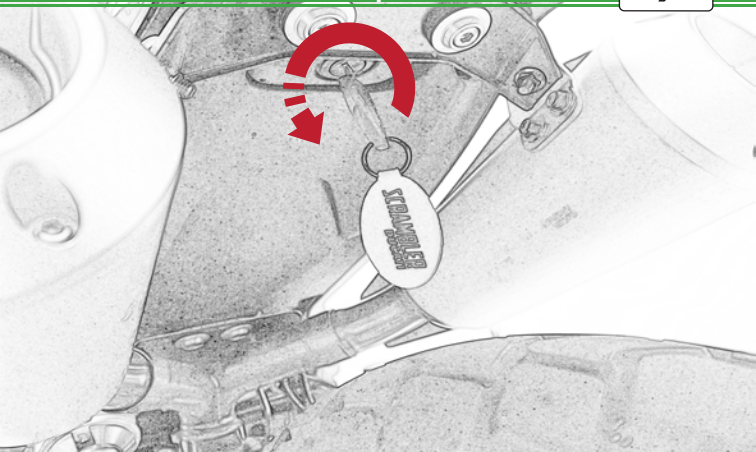

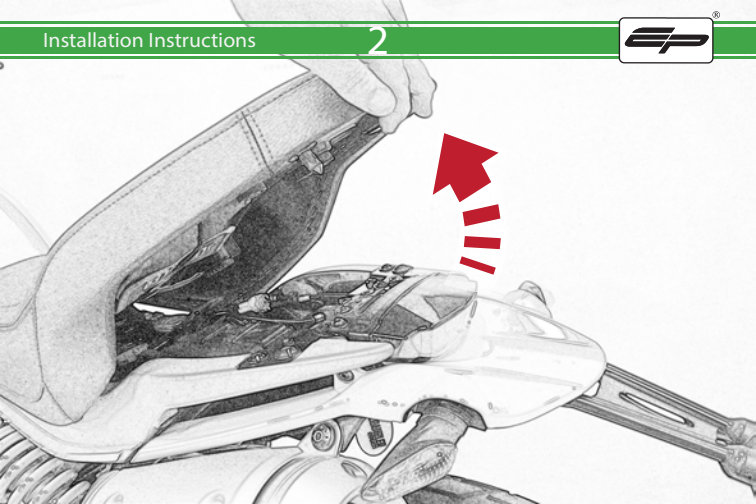

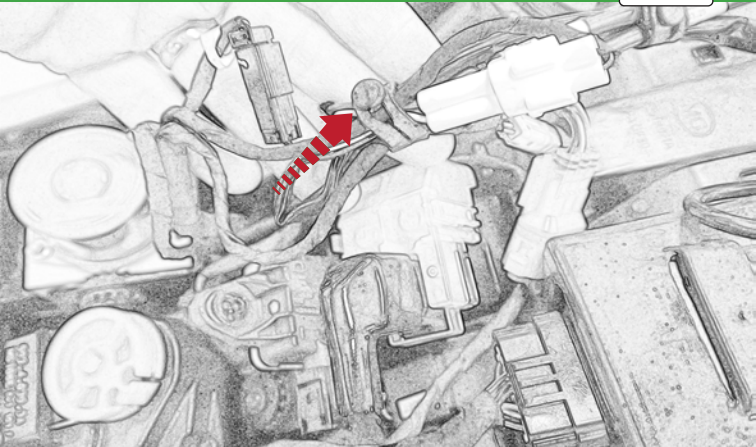

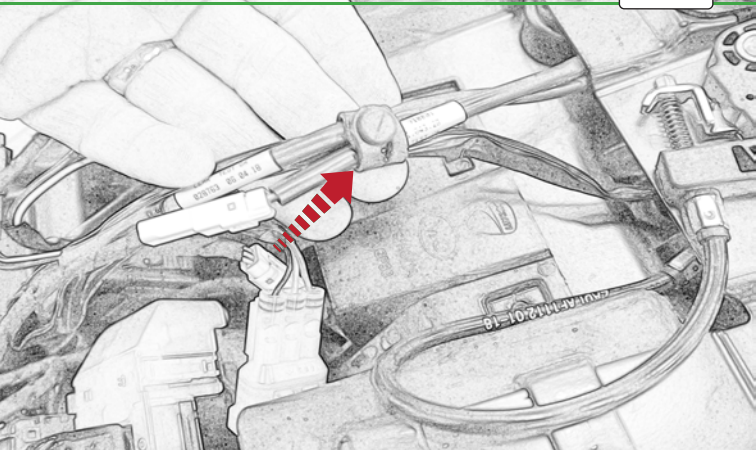

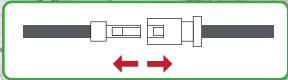
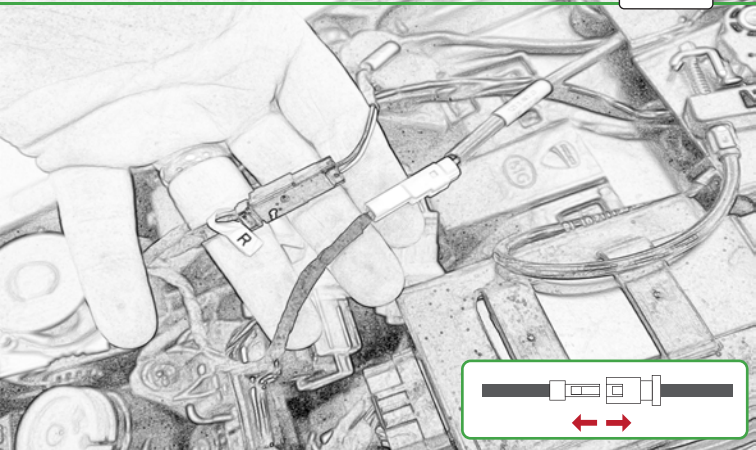

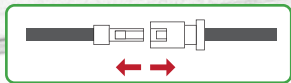
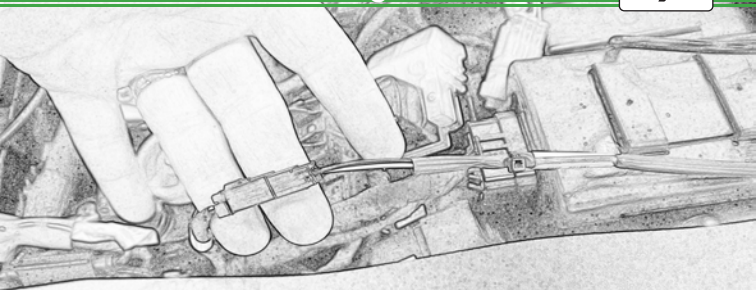



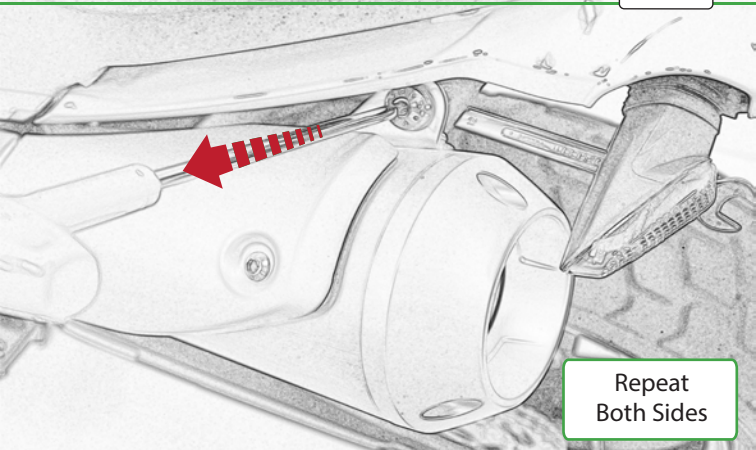

Repeat  
Both Sides

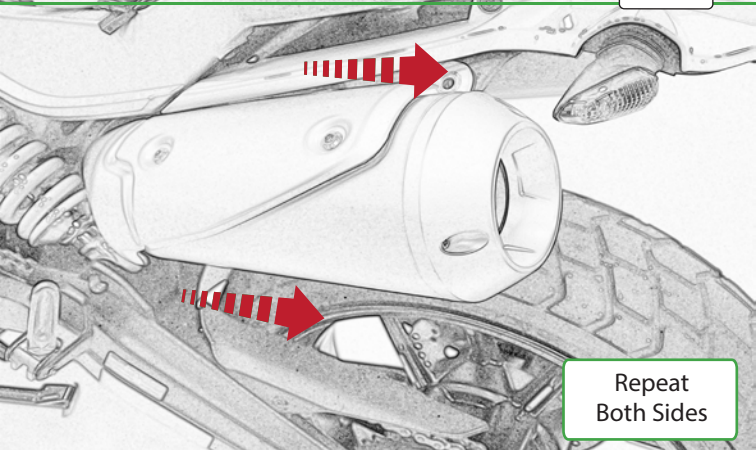

Repeat  
Both Sides

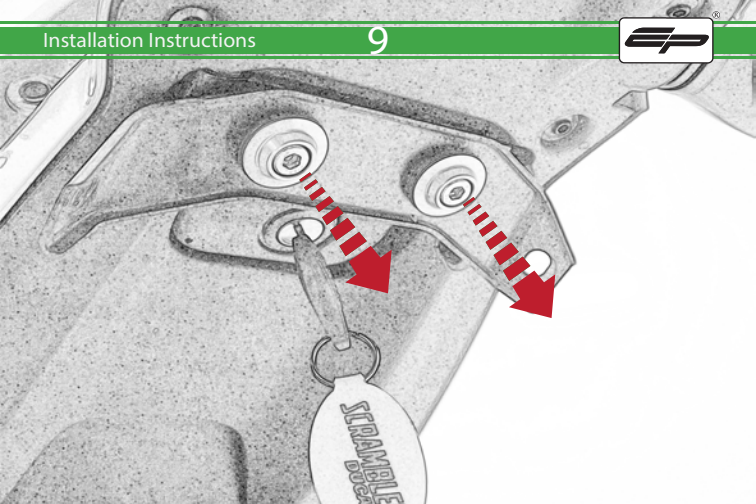

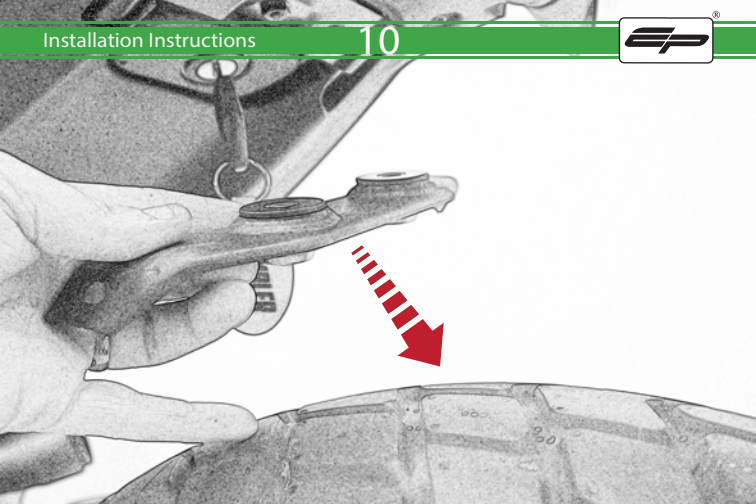

## Installation Instructions

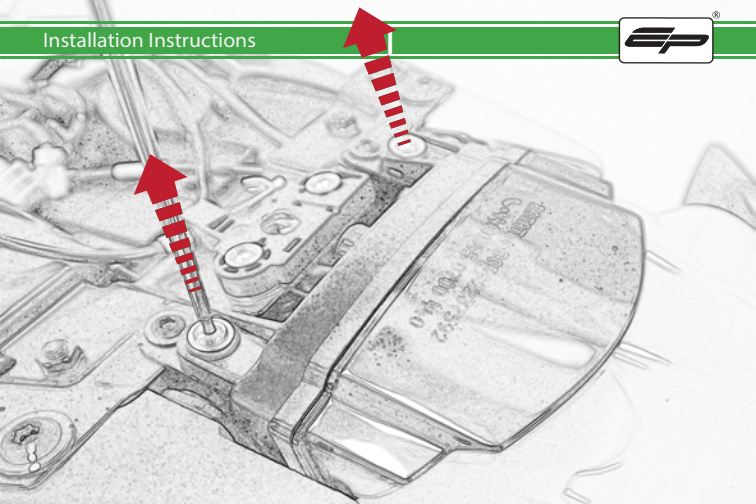



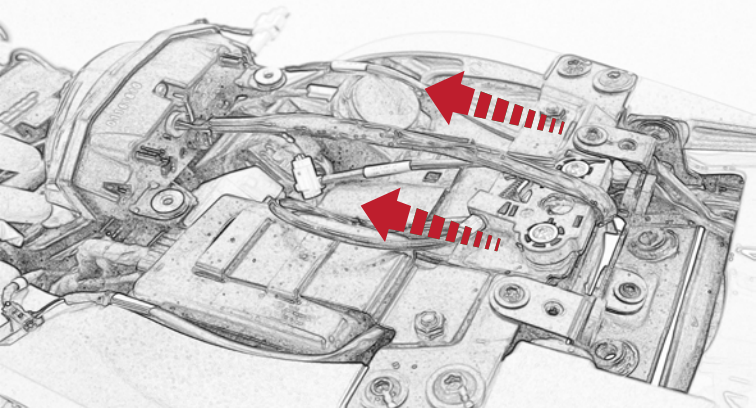

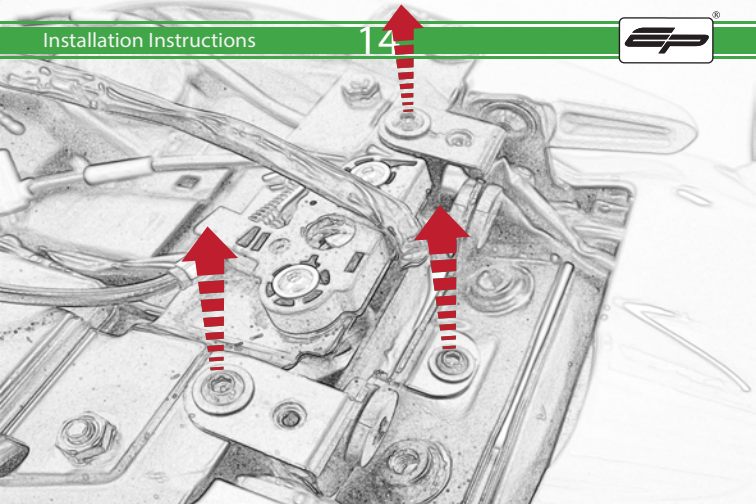



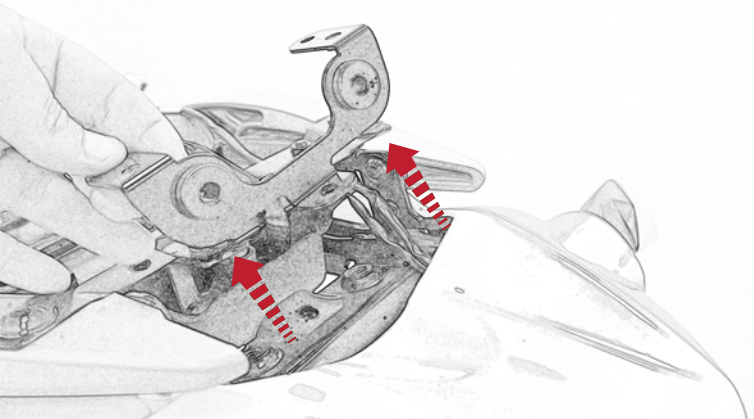

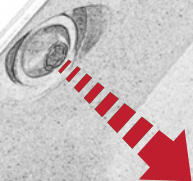

Repeat  
Both Sides

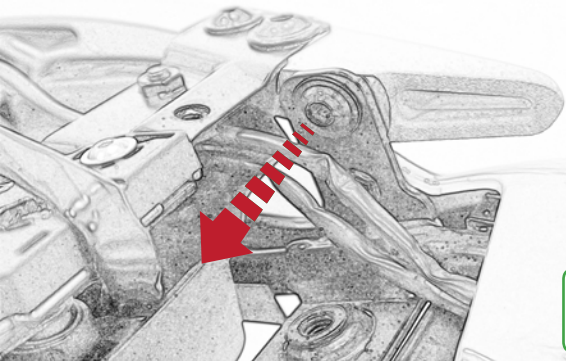

Repeat  
Both Sides

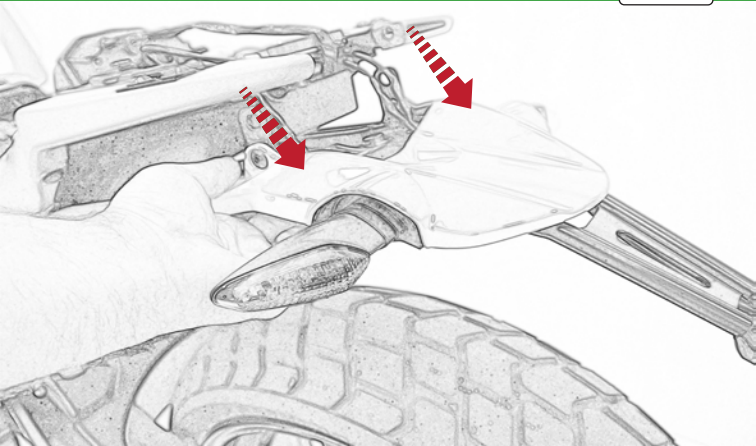

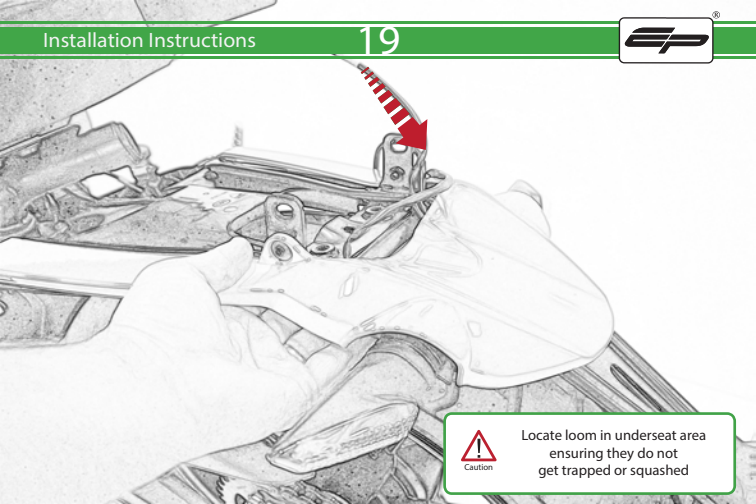

Locate larm in underseat area  
ensuring they do not  
get trapped or squashed



Repeat  
Both Sides

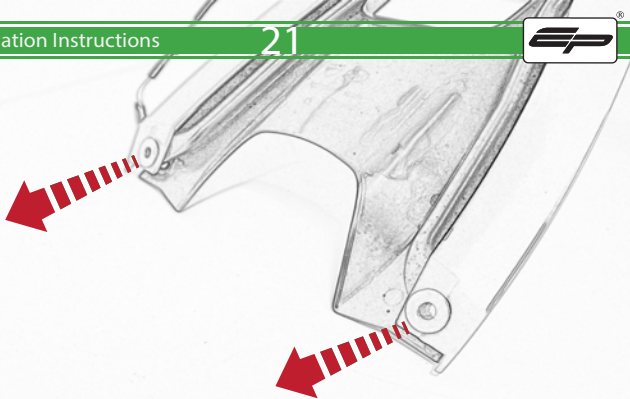

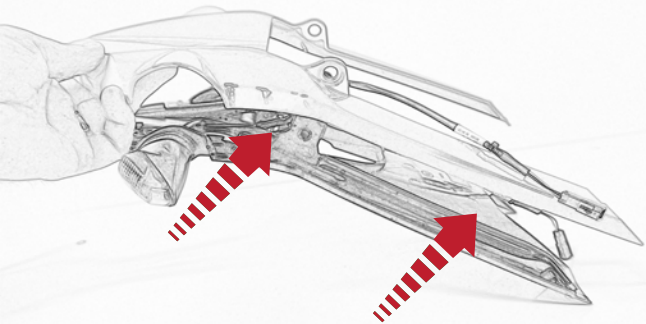



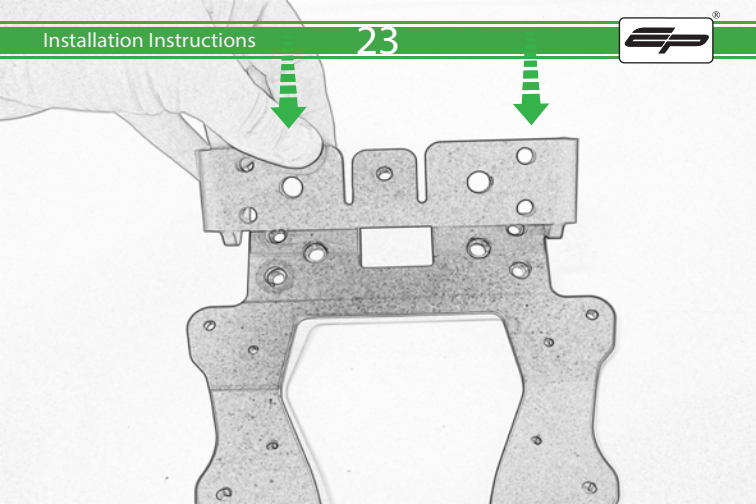

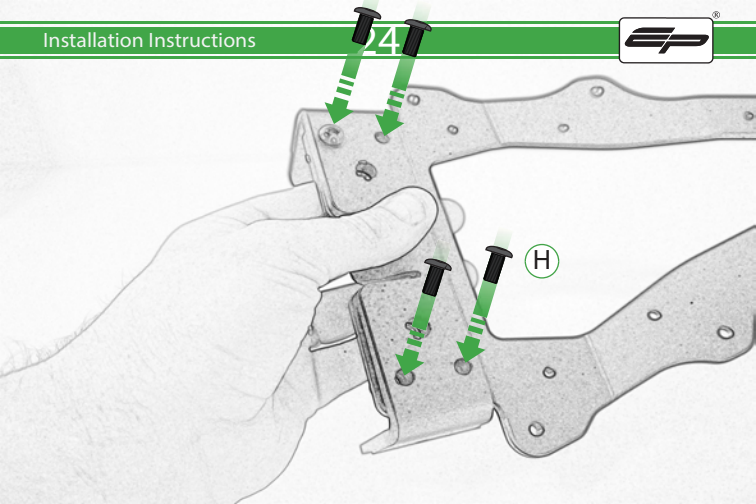

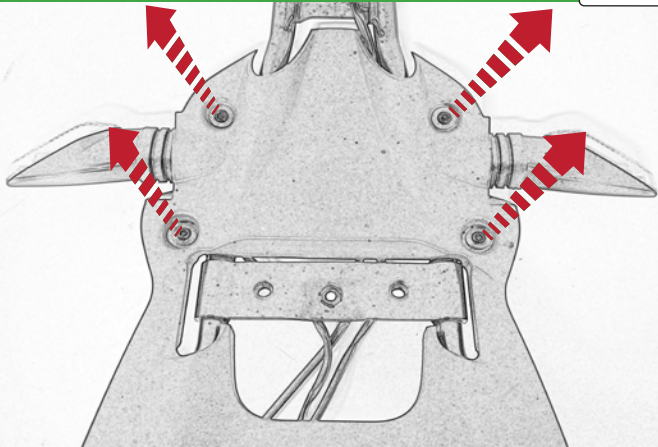

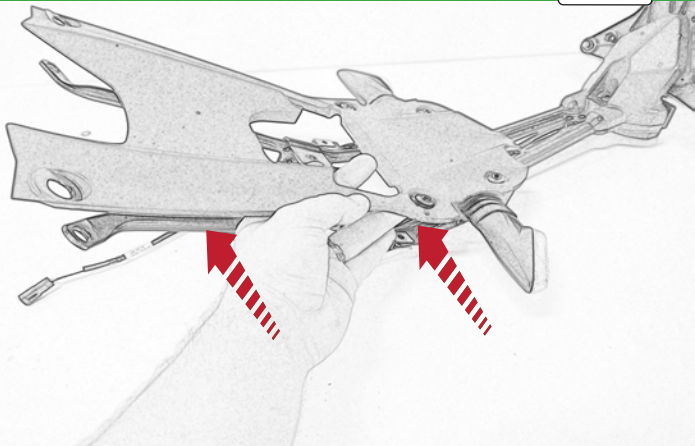

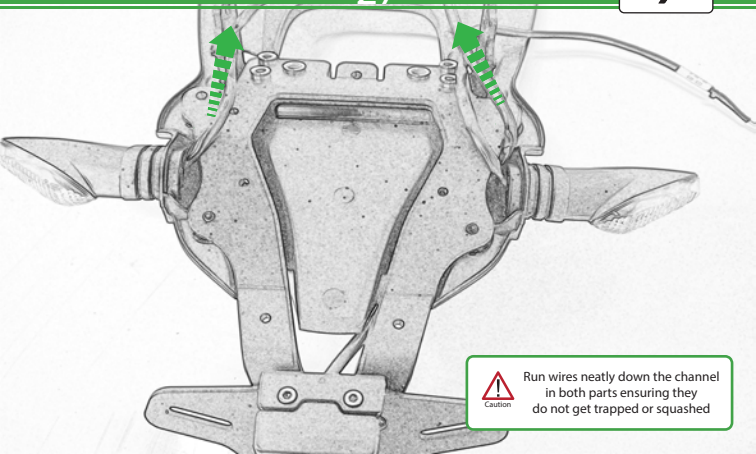

Caution

Run wires neatly down the channel in both parts ensuring they do not get trapped or squashed

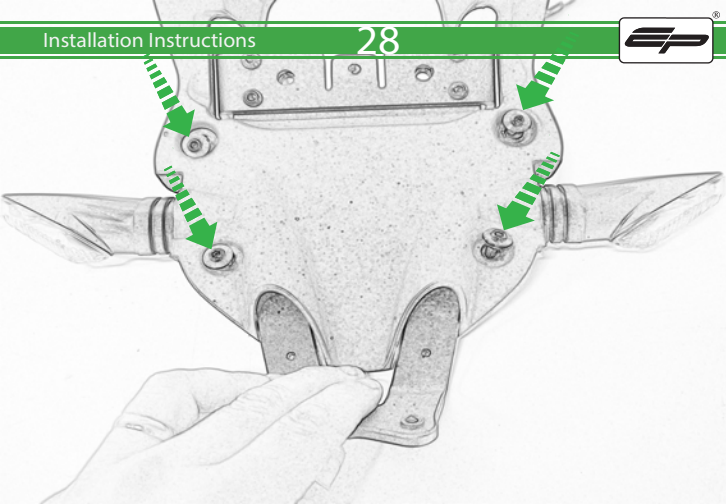

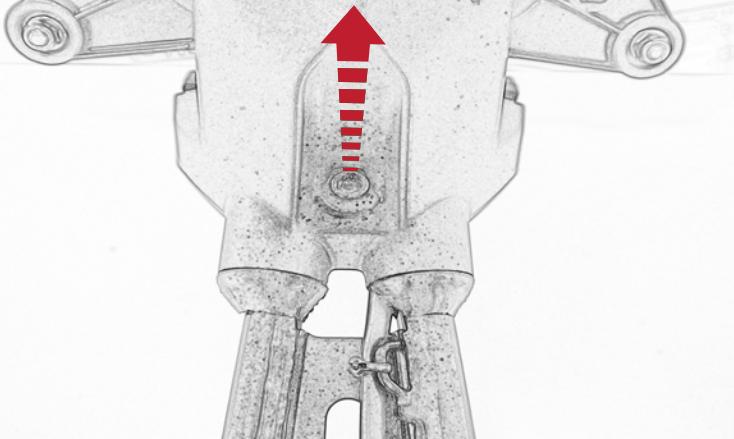

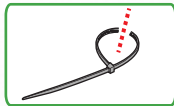
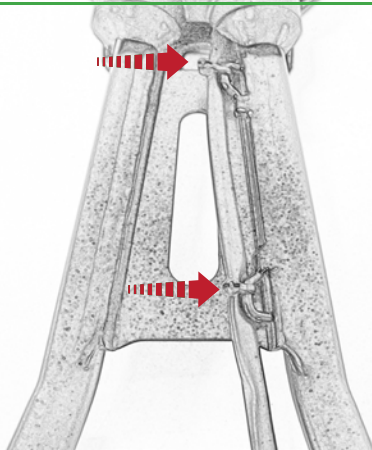



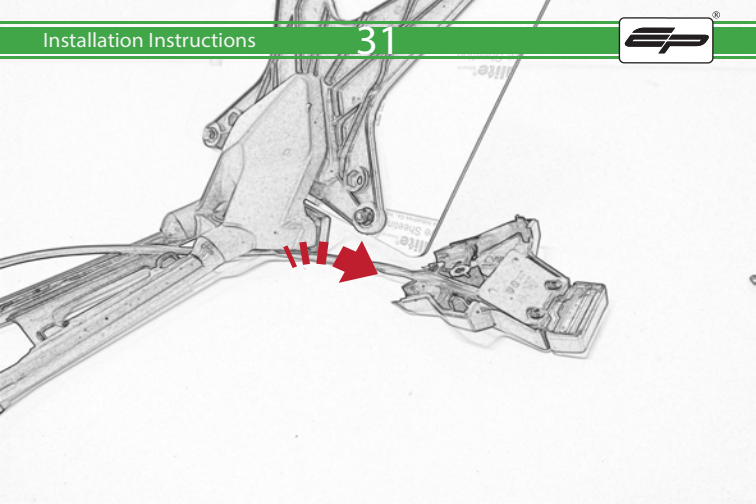

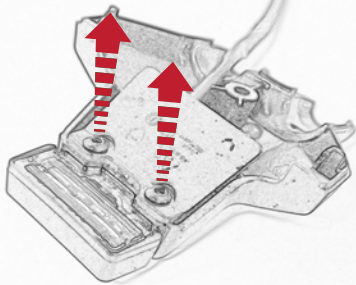

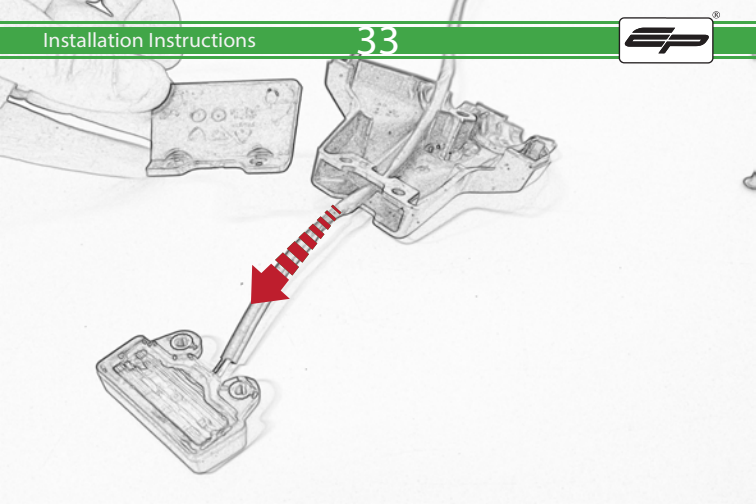

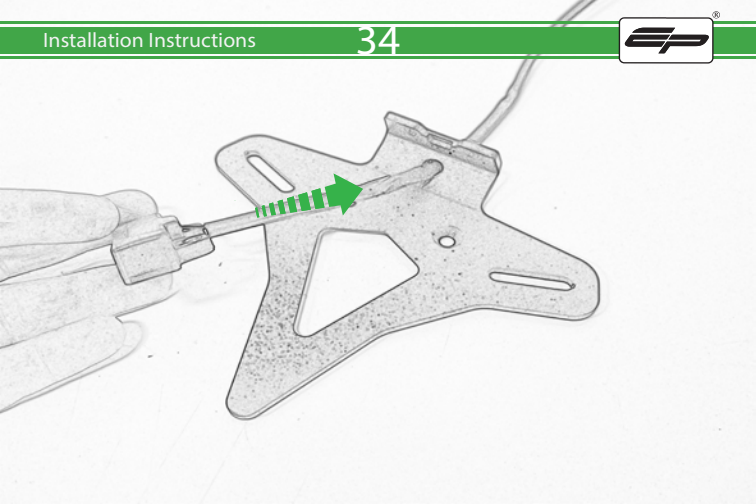

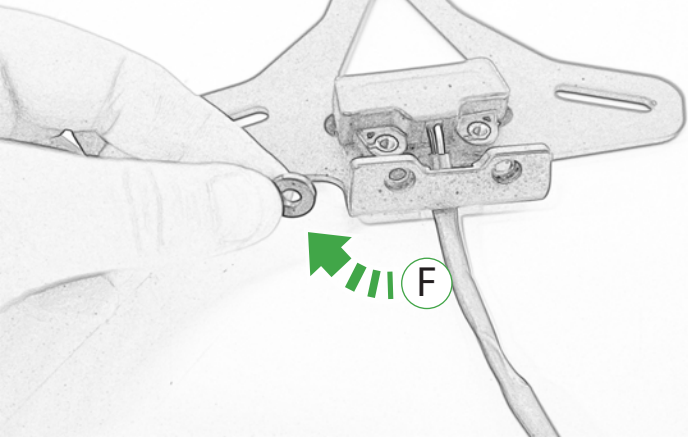

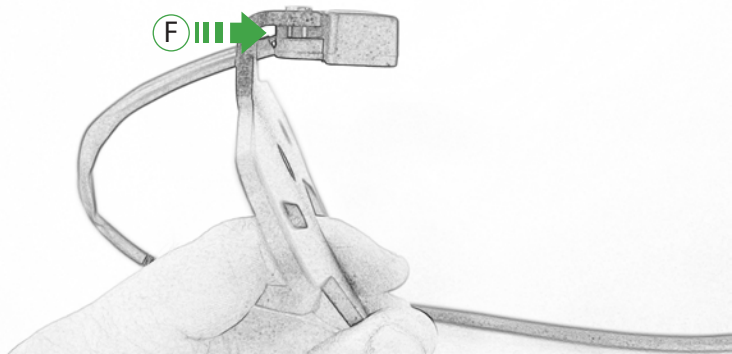

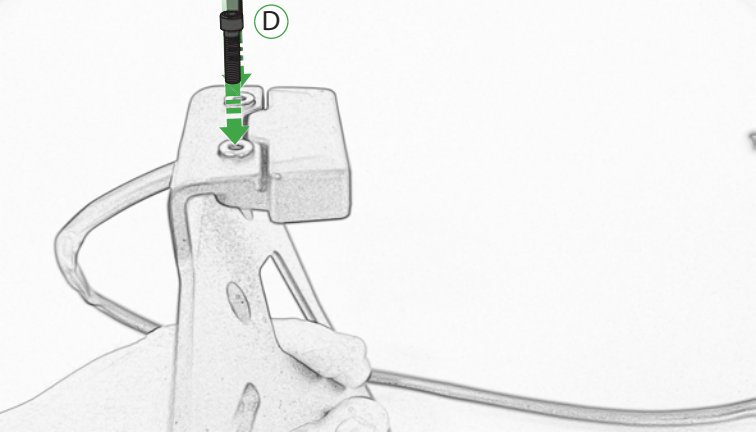

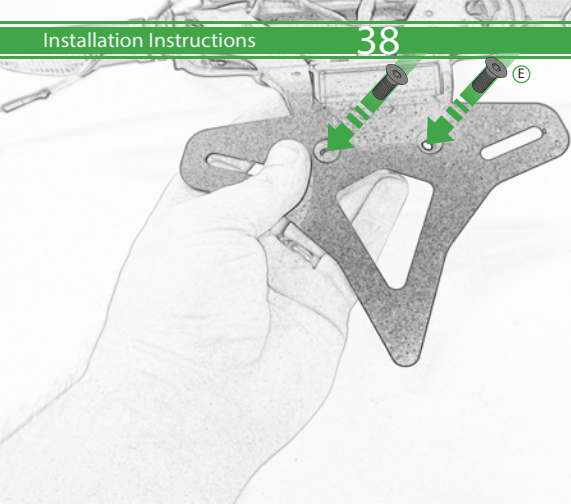



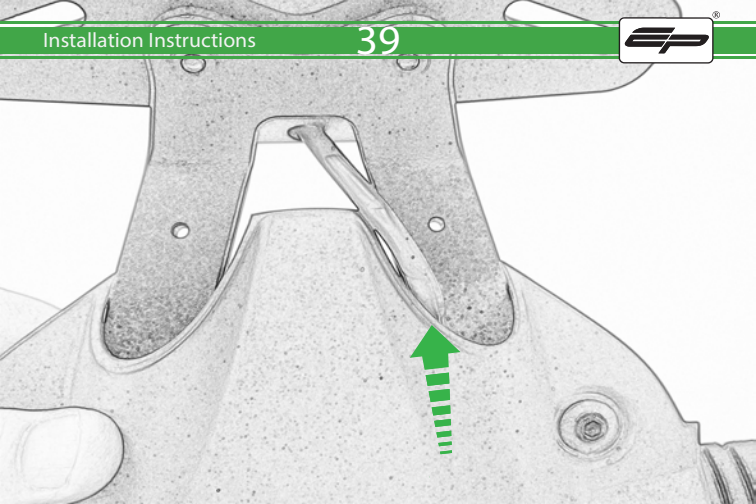

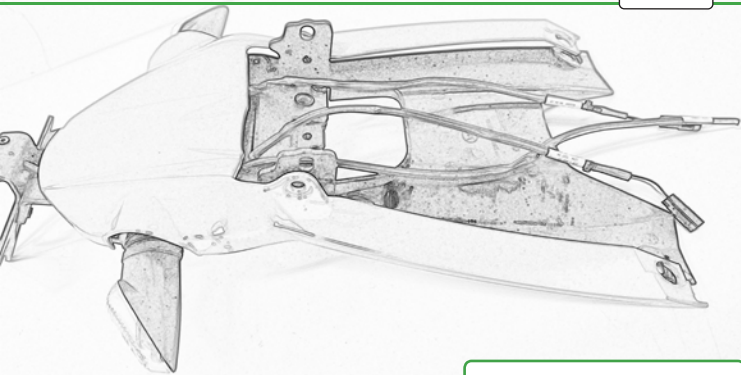

Caution

Run wires neatly down the channel in both parts ensuring they do not get trapped or squashed



OEM PART

The diagram shows a close-up of a vehicle's rear suspension assembly. A metal rod is being inserted into a circular hole in a metal housing. A green arrow with white diagonal stripes points from the text 'OEM PART' to the hole. Another green arrow with white diagonal stripes points from the bottom right towards the rod. The background is a light gray, semi-transparent image of the vehicle's chassis.

Repeat  
Both Sides



B

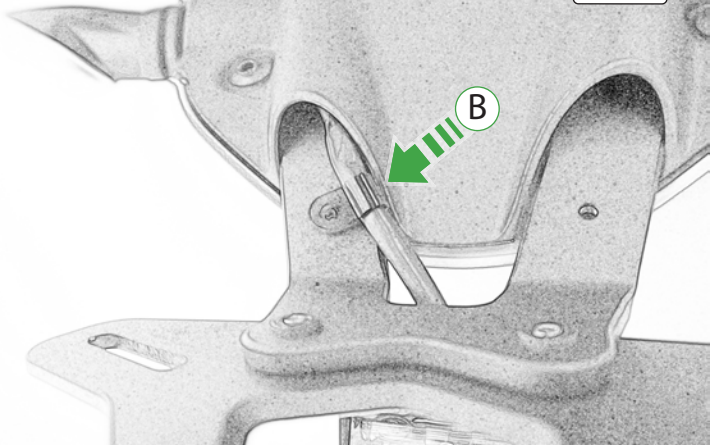



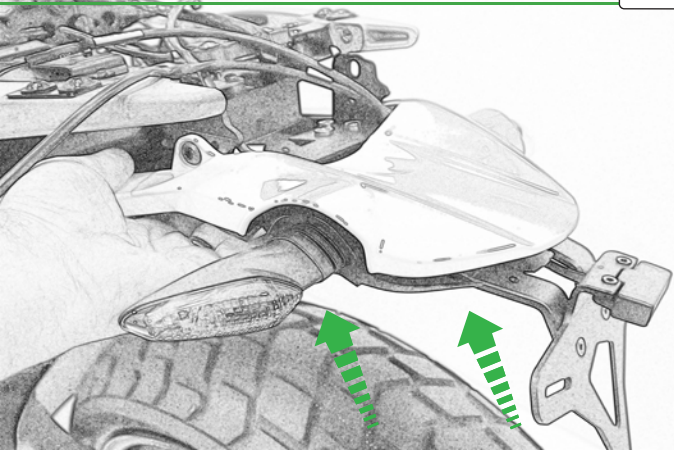

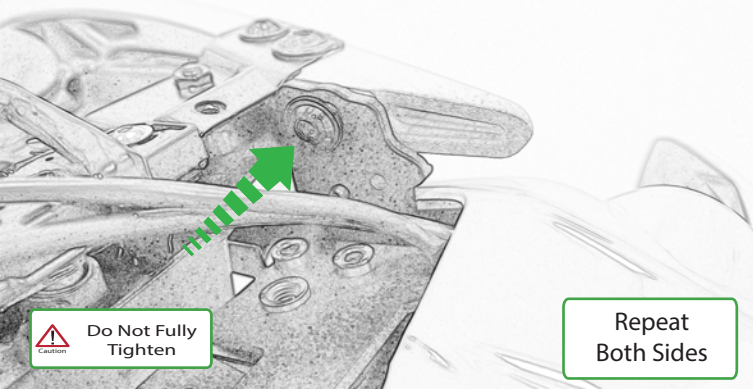

Do Not Fully  
Tighten

Repeat  
Both Sides



Do Not Fully Tighten



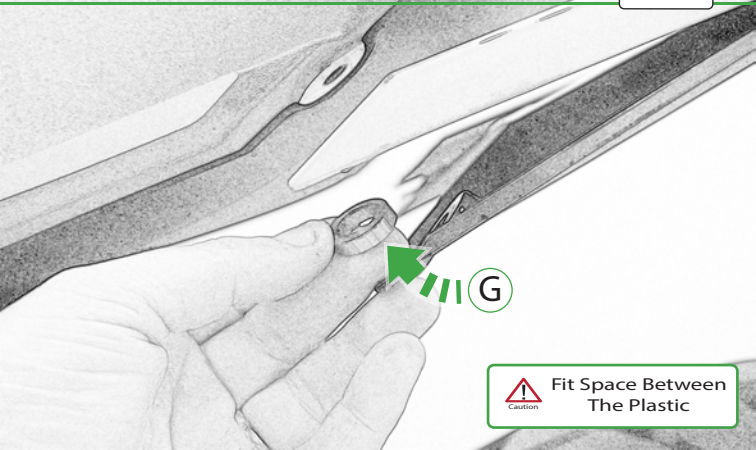

G



Caution

Fit Space Between  
The Plastic

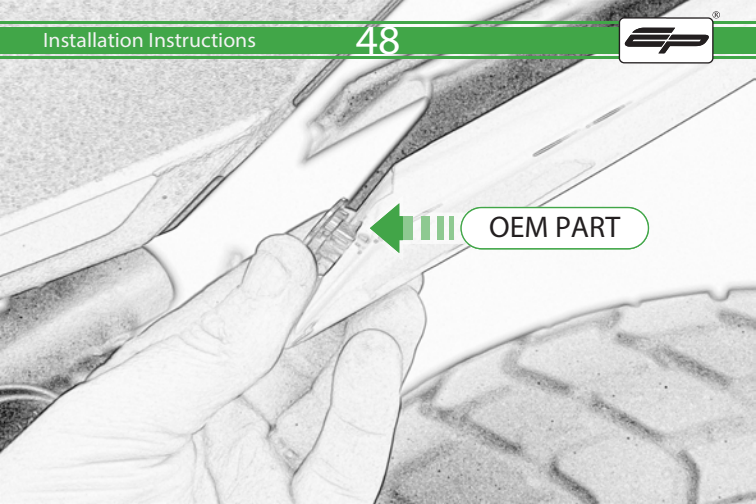

OEM PART

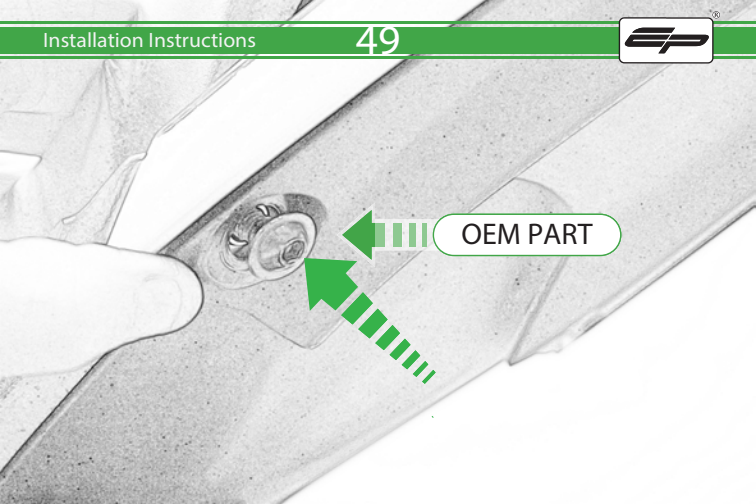

OEM PART

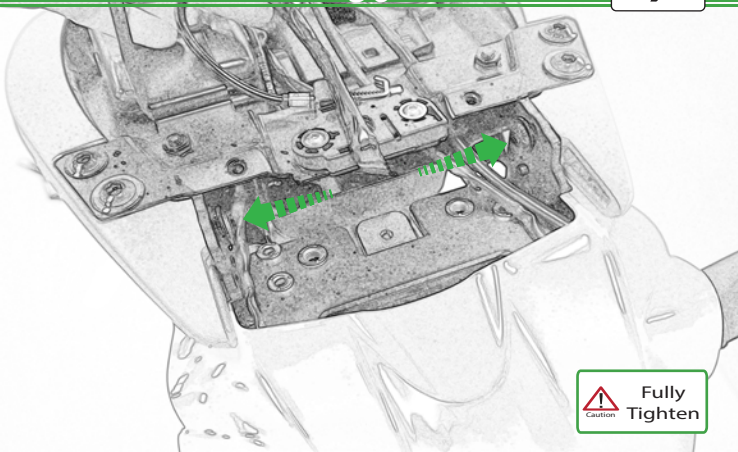

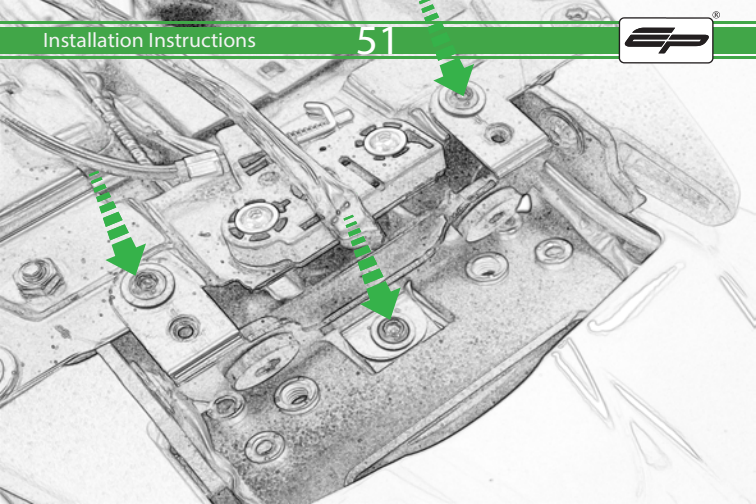

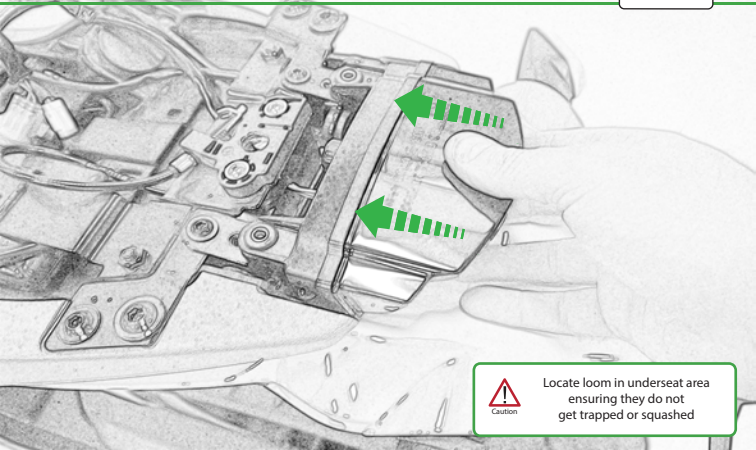

Locate loom in underseat area  
ensuring they do not  
get trapped or squashed



OEM PART

OEM PART



Caution

Locate loom in underseat area ensuring they do not get trapped or squashed

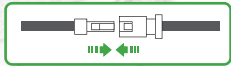
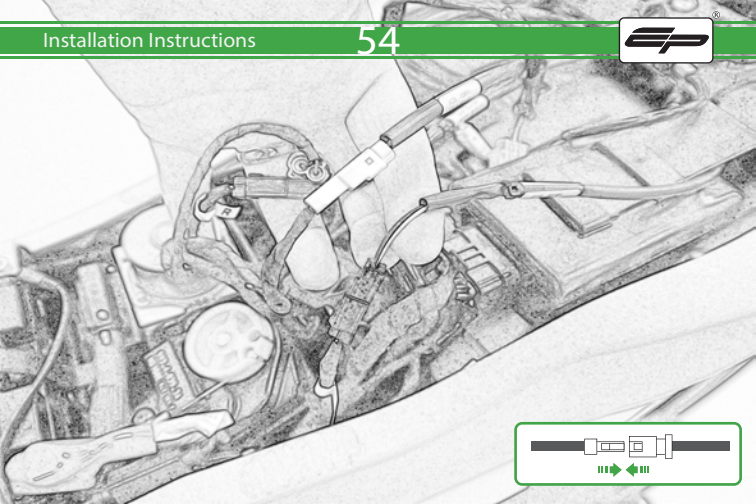





Reverse Stages

10 - 7

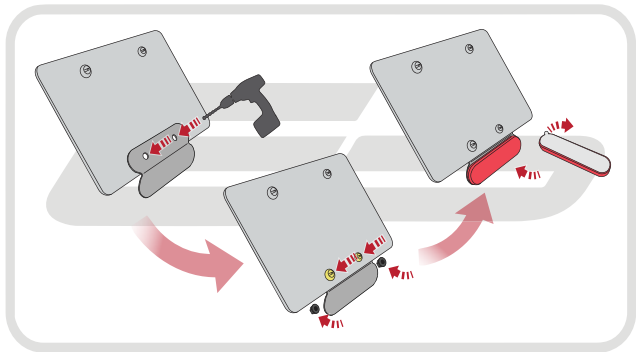

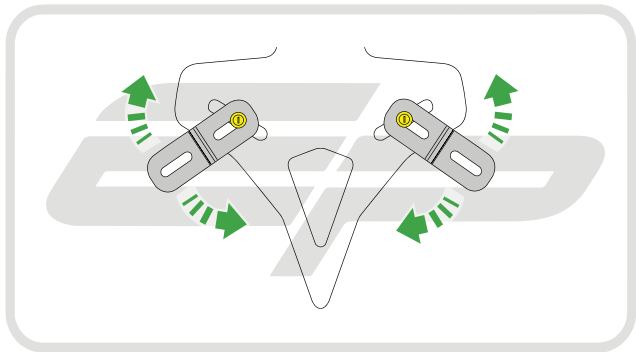



 **ESSENTIAL CHECKS** 

After installation of your tail tidy ensure that the licence plate does not contact the rear tyre when suspension is fully compressed.

Ensure all electrics including indicators, tail light, brake light and licence plate light lights are working correctly before riding the motorcycle.

It is recommended that periodic inspections are made to ensure that all fixings are fully tightend.



**EVOTECH**®  
P E R F O R M A N C E

[www.evotech-performance.com](http://www.evotech-performance.com)